

Thank you for your purchase!

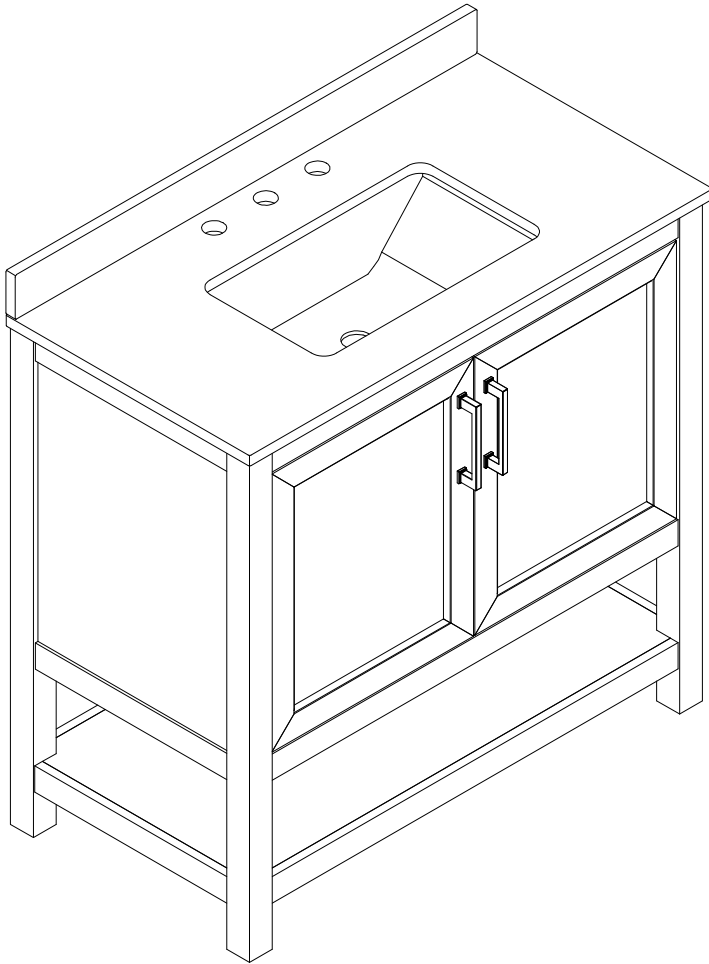

Bathroom Vanity



ASSEMBLY INSTRUCTIONS

Before You Begin: Please see the required tools list (not included)

Please identify all component parts and hardware pieces required before you begin. Carefully remove all of the components from the packaging and set aside for assembly. Assemble on a soft surface to prevent scratching during assembly.

Caution:

Tighten all components securely before use. Failure to do so may result in personal injury. DO NOT use any sharp objects to open plastic wrapped components as damage to product or components may result.

Warning:

CHOKING HAZARD - Small Parts. Adult Assembly Required.

DO NOT ALLOW CHILDREN TO CLIMB ON FURNITURE

Serious or fatal injuries can occur from furniture tipping over. You must install Tipping Restraint Hardware (where included) to help prevent the unit from tipping and causing accidental injury, instability, death or damage. The tipping restraint is intended only as a safety measure, it is not a substitute for proper adult supervision.

To help prevent furniture from tipping over it must be permanently attached to the wall. Anti-Tip Safety Wall Straps suitable for the unit weight and wall materials (if not included) should be purchased and installed.

Customer Service Email: Customerexperience@theubiquegroup.com | Phone: 866-552-2810

196861105920 / 196861105937 / 196861105944



Congratulations!

You just purchased a piece of happiness. At Ubique Group, we believe you can transform your spaces into the most inspired places with furnishings that are the perfect combination of form, function and style. As original innovators of online furniture retail, we offer the best selection of popular, contemporary styles at cool, comfortable prices. And, with decades of proven shipping and packaging expertise, our Extended Quality Checklist ensures a rewarding, hassle-free experience time and time again. It's just what you need to bring your vision to life.

Thank you & Enjoy!!
your friends at Ubique Group



LIKE IT!

*Share it on social
& Tell a friend!
#Spaces2Places*



LOVE IT!

*Write an online
product review
where purchased*



NOT SURE?

*Let us help!
Contact our
customer support.*

Have a question, concern or simply need a hand? Your satisfaction is our top priority. Contact us at 866-552-2810 or customerexperience@theubiquegroup.com. We're here to help!

Browse Our Branded Collections

There's something for everyone inside our family of brands.



MERRICK | LANE

Taylor & Logan

Emma+Oliver



BlackArc

Visit www.theubiquegroup.com/brands or scan this code.





We pride ourselves on providing an excellent customer experience starting right here with your package and instructions. Everything you need should be right where you need it, so you can get to enjoying your new item ASAP. But despite our best efforts, sometimes "slips happen." If you need any support, from replacement parts to recommendations, please reach out to our wonderful customer support team at 866-552-2810 or customerexperience@theubiquegroup.com. We're here to help!

EVERY UBIQUE GROUP PRODUCT



Quality &
Durability Tested



Packaged
with Care



Shipped from
our U.S. Facility

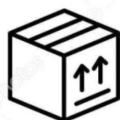

Designed
for Easy
Assembly



Ethically
Sourced

Please visit <https://www.theubiquegroup.com/warranty> for complete warranty information.

Read this manual before using this product. Failure to follow the instructions and safety precautions in this manual can result in serious injury or death. Keep this manual in a safe location for future reference.

PARTS LIST

(A) 1PC

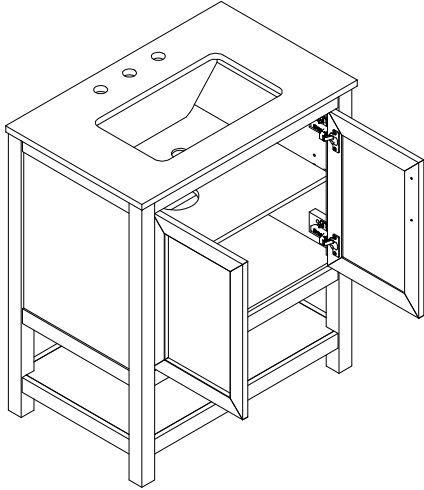

(B) 1PC

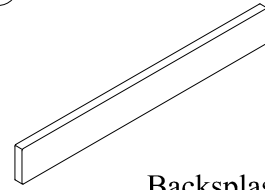

Backsplash

(C)

2PCS



Handle

(D)

4PCS

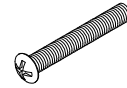

Bolt 5/32"*25mm

TOOLS REQUIRED (Not Included)

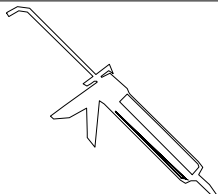

Silicone
Sealant

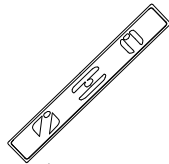

Level



Phillips
Screwdriver

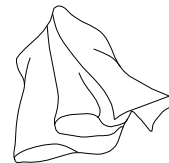

Clean rag

INSTALLATION

STEP 1: Installing the backsplash (optional)

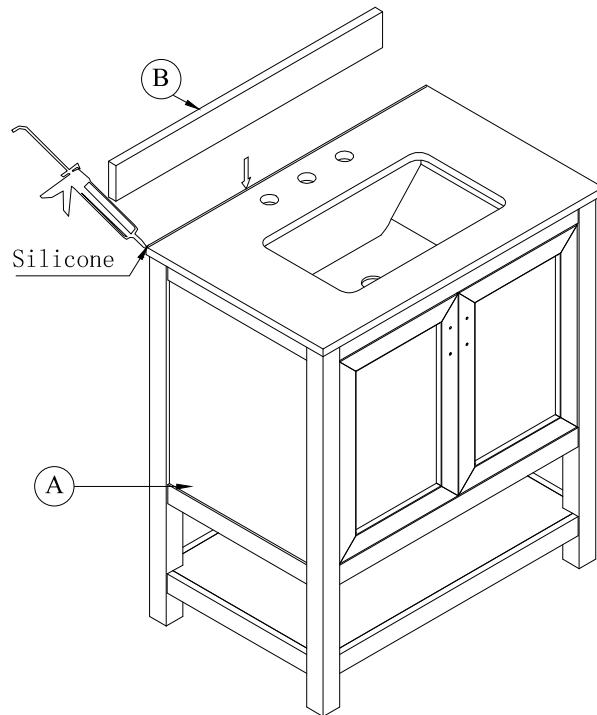

STEP 2

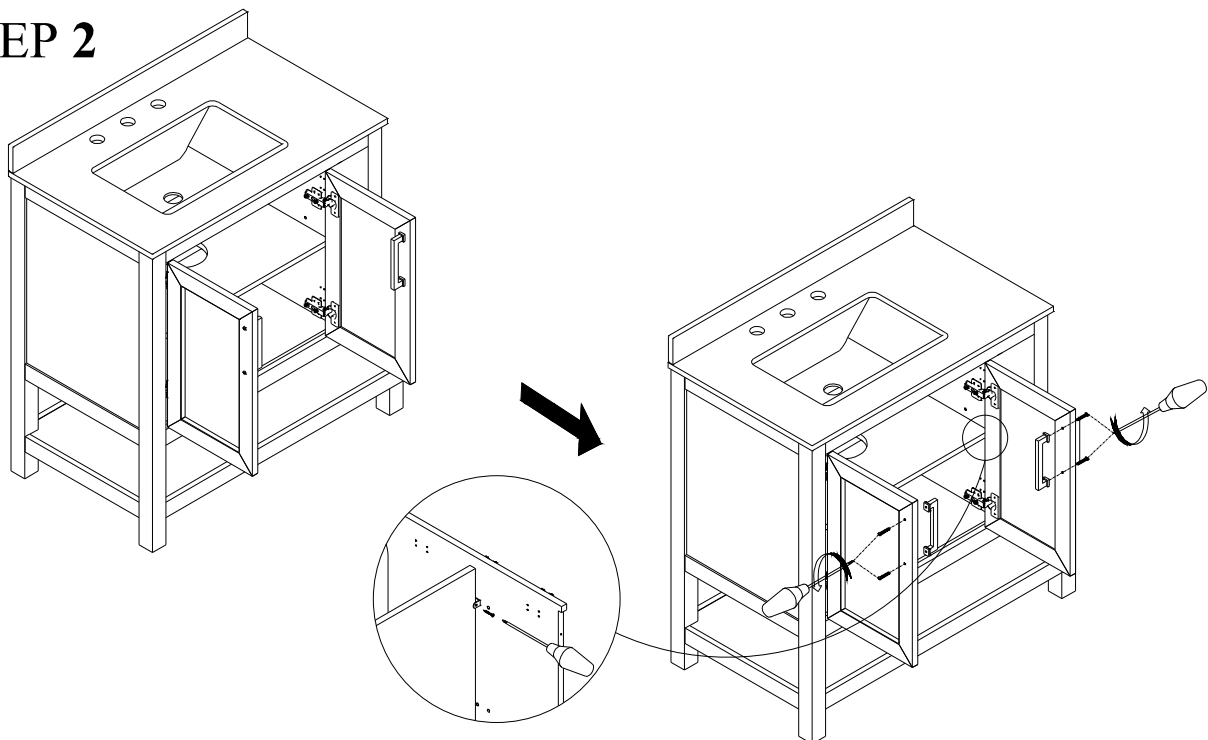

STEP 3

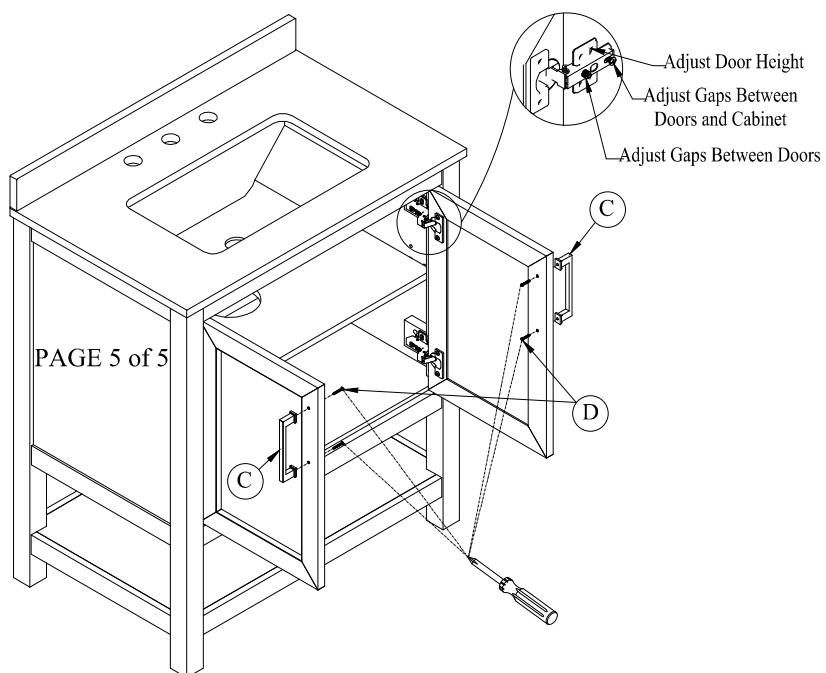

STEP 4

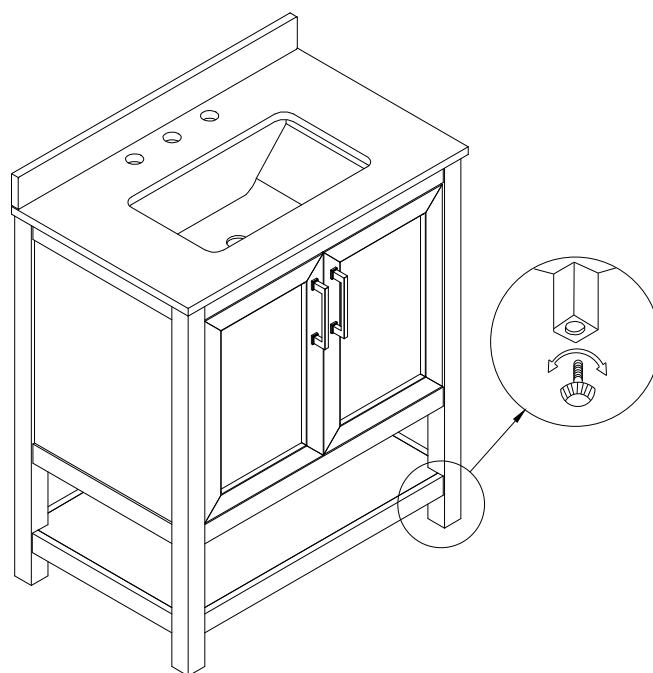

Quality and Safety Guidelines:

Please follow the static and dynamic weight capacity limits provided on this item. If you are unsure of the weight capacities for this product, email us at customerexperience@theubiquegroup.com or call 866-552-2810.

Please use this item on a stable, level surface only. All vanity legs should contact the flooring surface when in use. Do not use this item if any instability is detected.

Please install and use anti-tipping devices, wall anchors or attach directly to wall with appropriate hardware.

For maintenance instructions and replacement parts, please email us at customerexperience@theubiquegroup.com or call 866-552-2810.

This item is intended as a bathroom vanity only, do not climb, stand or sit on this item. Do not use this item as a TV stand.

Keep fingers away from the hinge line clearance to avoid pinching.

The item is intended to be used indoors.

For product longevity, product safety and product integrity, protect from wet and humid weather or other wet, humid or moist conditions and store indoors in a dry location. For additional storage and usage instructions, please email us at customerexperience@theubiquegroup.com or call 866-552-2810.

Please visit www.theubiquegroup.com for our product warranty details or email us at customerexperience@theubiquegroup.com or call 866-552-2810.