

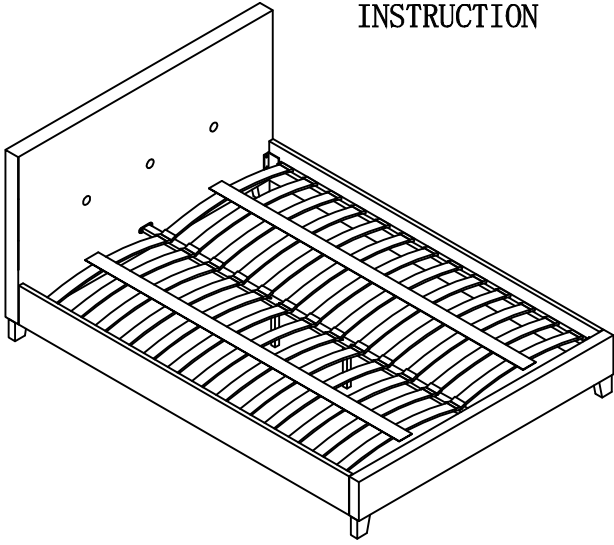









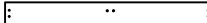







PLATFORM BED FRAME INSTRUCTION



Components

①  1PC	②  1PC	③  2PCS
④  1PC	⑤  2PCS	⑥  30PCS
⑦  2PCS	Ⓐ  12PCS	Ⓑ  4PCS
Ⓒ  4PCS	Ⓓ  4PCS	Ⓔ  20PCS
Ⓕ  1PC	Ⓖ  1PC	Ⓖ  4PCS
Ⓘ  30PCS	Ⓙ  15PCS	Ⓚ  2PCS

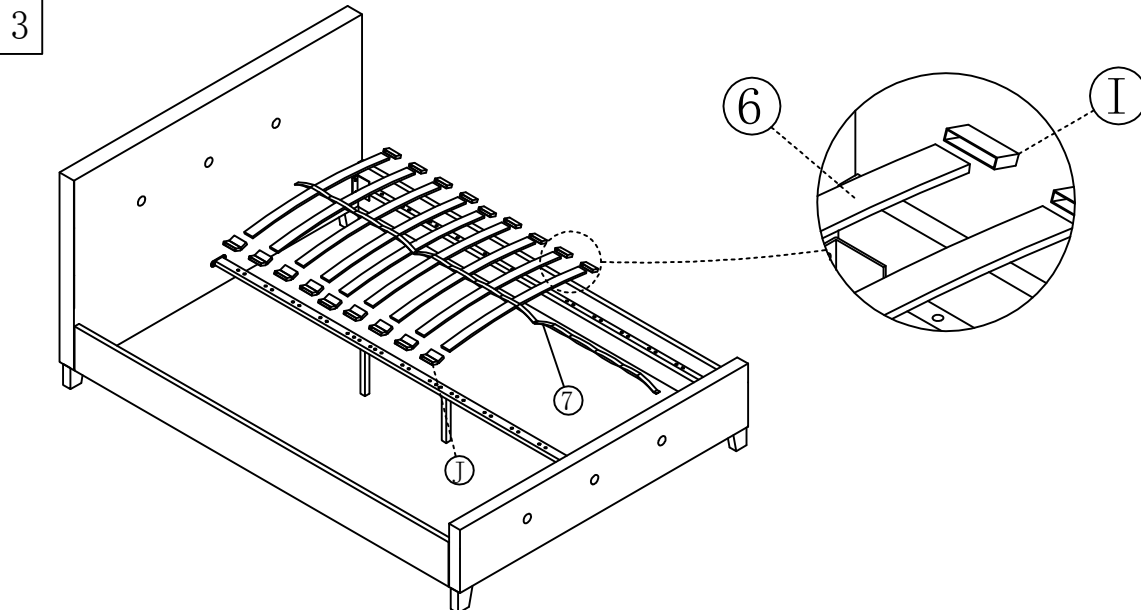
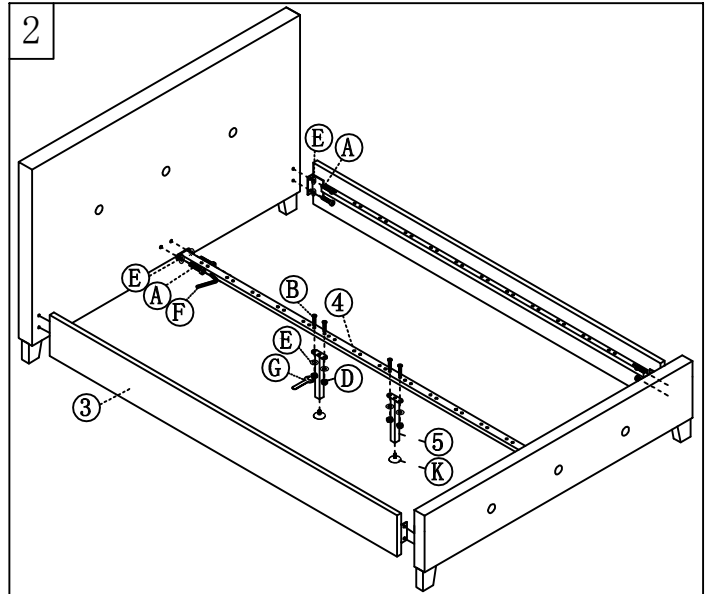
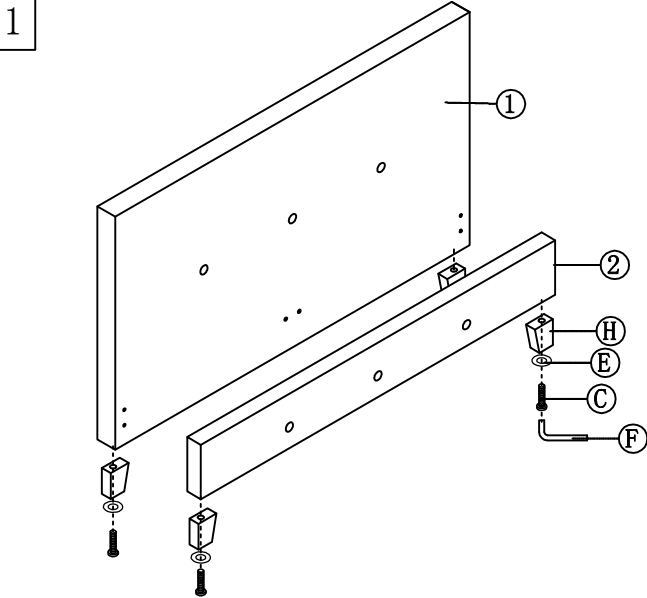

4

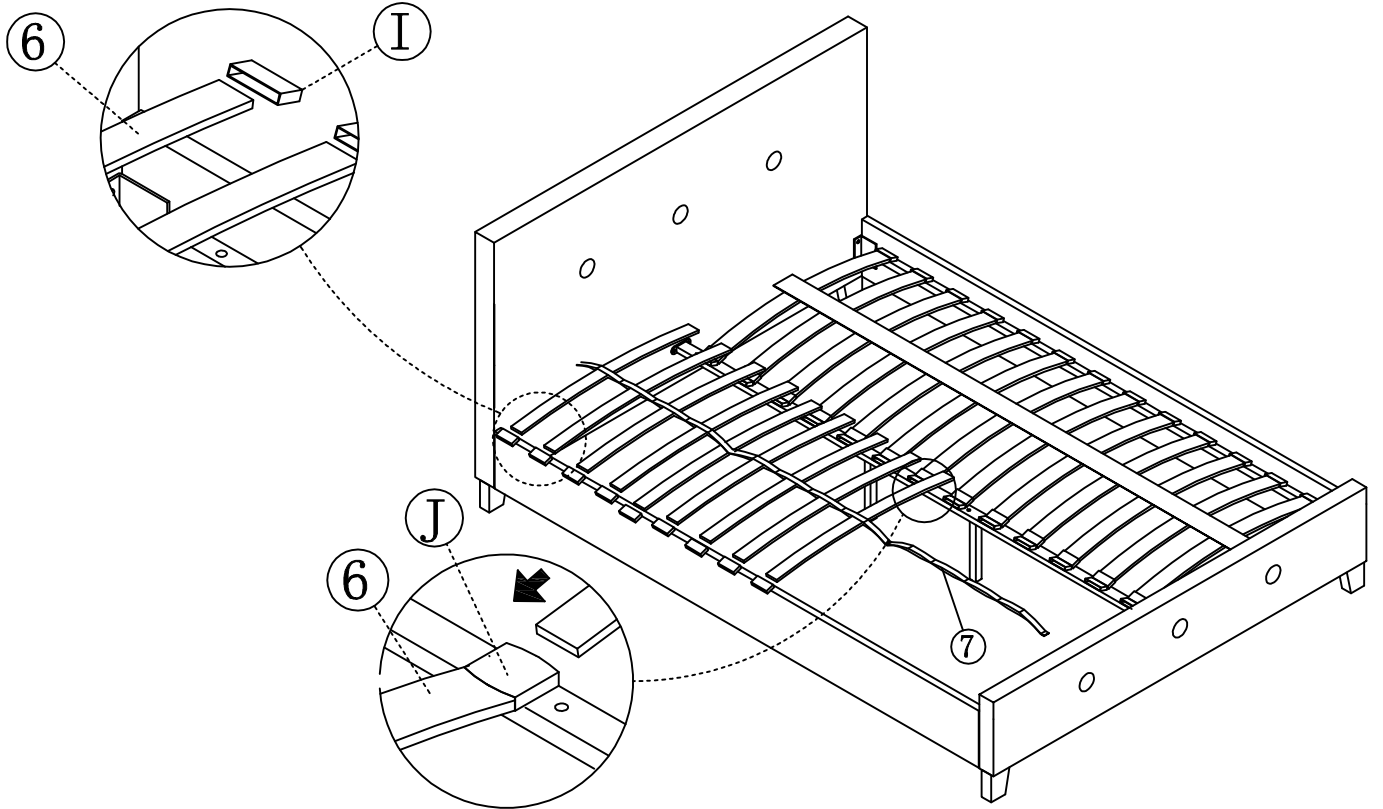

5

