

Thank you for your purchase!

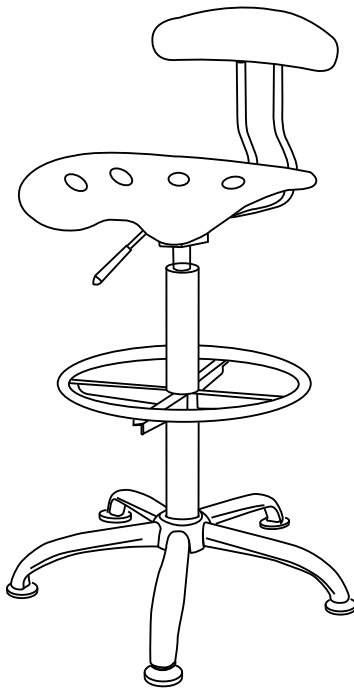

HEIGHT ADJUSTABLE DRAFTING STOOL WITH TRACTOR SEAT

ASSEMBLY INSTRUCTIONS

Before You Begin:

Please identify all component parts and hardware pieces required before you begin. Carefully remove all of the components from the packaging and set aside for assembly. Assemble on a soft surface to prevent scratching during assembly.

Caution:

Tighten all components securely before use. Failure to do so may result in personal injury.

DO NOT use any sharp objects to open plastic wrapped components as damage to product or components may result.

Warning:

CHOKING HAZARD - Small Parts. Adult Assembly Required.

DO NOT ALLOW CHILDREN TO CLIMB ON FURNITURE

Serious or fatal injuries can occur from furniture tipping over. You must install Tipping Restraint Hardware (where included) to help prevent the unit from tipping and causing accidental injury, instability, death or damage. The tipping restraint is intended only as a safety measure, it is not a substitute for proper adult supervision.







To help prevent furniture from tipping over it must be permanently attached to the wall. Anti-Tip Safety Wall Straps suitable for the unit weight and wall materials (if not included) should be purchased and installed.

Online Assembly Instructions: <http://ftp.flashfurniture.com/AssemblyInstructions/LF-215-ORANGEYELLOW-GG.pdf>

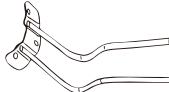
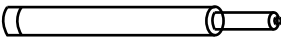
Customer Service Email: CustomerExperience@belnick.com | Phone: 866-552-2810

LF-215-SILVER-GG/LF-215-DEEPBLUE-GG/LF-215-BLK-GG/LF-215-APPLEGREEN-GG/LF-215-WINERED-GG/LF-215-YELLOW-GG/LF-215-PINK-GG/LF-215-VIOLET-GG/LF-215-RED-GG
LF-215-GREEN-GG/LF-215-BRIGHTBLUE-GG/LF-215-ORANGEYELLOW-GG/LF-215-WHITE-GG/LF-215-SPICYLIME-GG/LF-215-NAUTICALBLUE-GG/LF-215-CHERRYTOMATO-GG

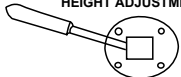
PARTS

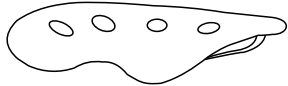
A	 5 STAR BASE	1	F	SEAT BACK ATTACHMENT FRAME 	1
B	COLUMN 	1	G	BACK REST 	1
C	FOOT REST 	1	H		5
D	HEIGHT ADJUSTMENT MECHANISM 	1	I	ALLEN WRENCH 	1
E	TRACTOR SEAT 	1			

STEP 1

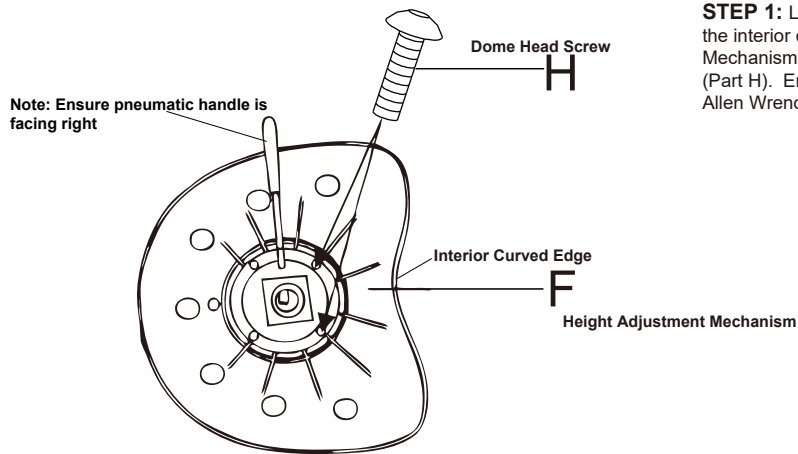

STEP 1: Lay the Tractor Seat face down on a soft clean surface with the interior curved edge toward you. Attach the Height Adjustment Mechanism (Part F) to the Tractor Seat using (2) Dome Head Screws (Part H). Ensure mechanism handle is facing right. Tighten with the Allen Wrench (Part I)

STEP 2

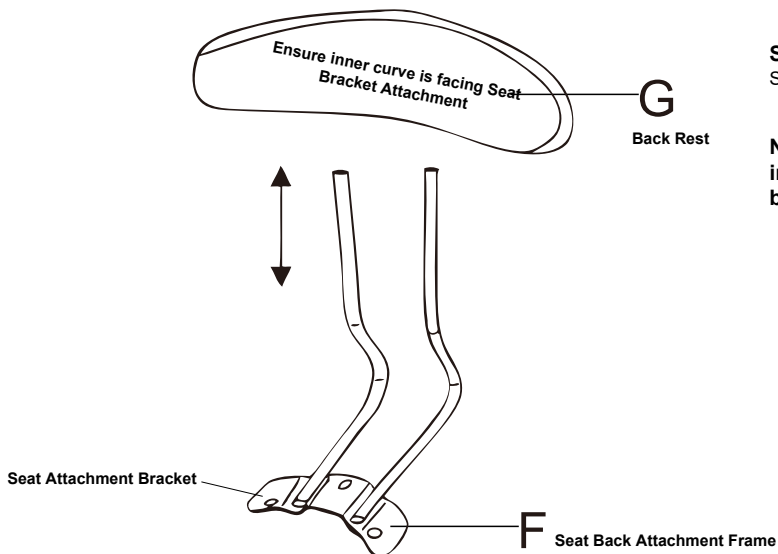

STEP 2: Push Seat Back (Part G) onto posts of Seat Back Attachment Frame (Part F).

Note: Ensure curve of backrest is facing inwards toward the seat attachment bracket.

STEP 3

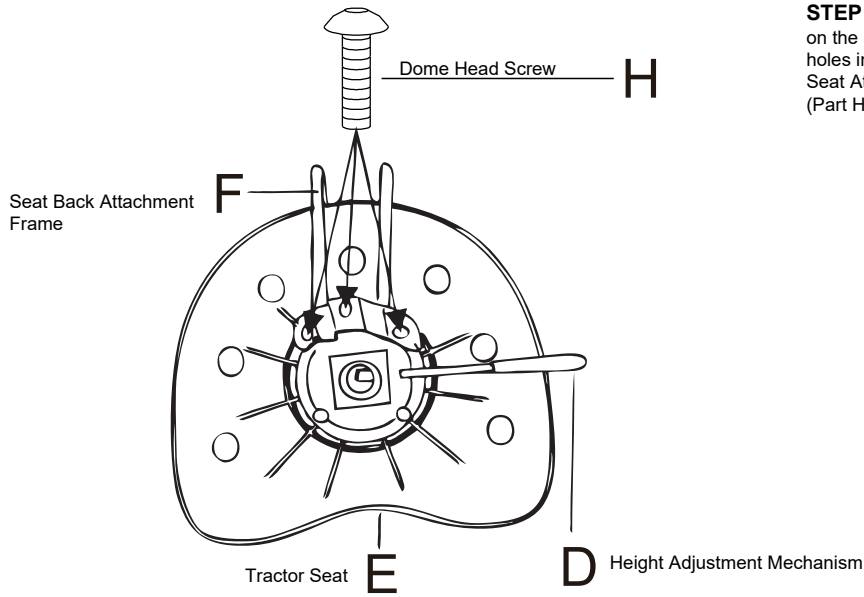

STEP 3: Place the Seat Back Attachment Frame (Part F) on the underside of the Tractor Seat (Part E) on top of the holes in the Height Adjustment Mechanism. Attach the Seat Attachment Bracket using (3) Dome Head Screws (Part H). Tighten with the Allen Wrench (Part I)

STEP 4

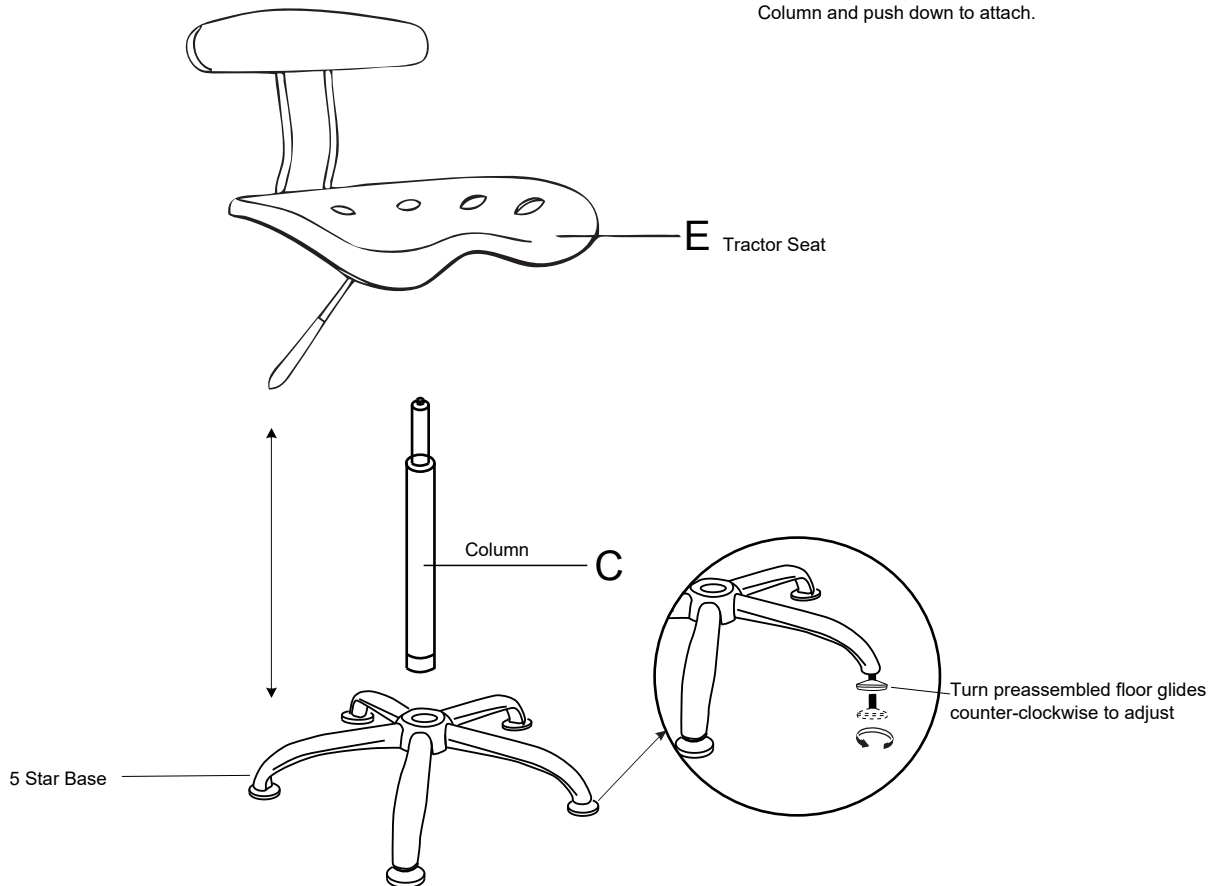

STEP 4: Insert larger end of the Column (Part C) into the 5 Star Base (Part A). Place the assembled seat onto the Column and push down to attach.

